

# 4.0 and 6.5 MM CANNULATED SCREWS

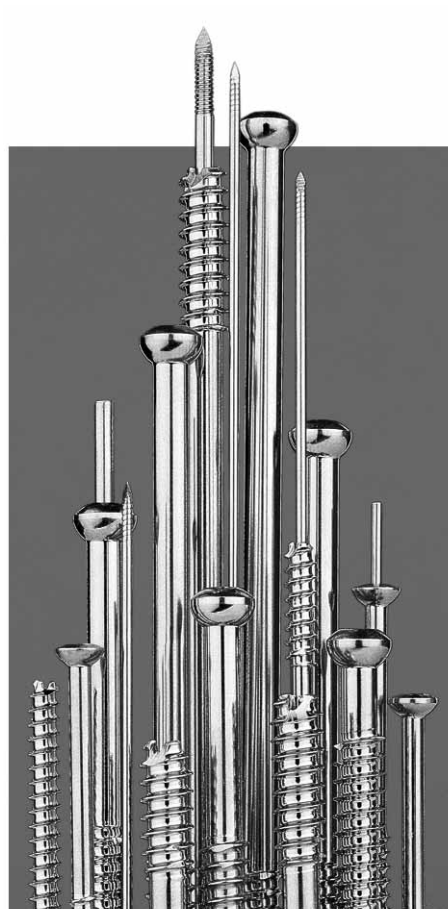



# 6.5 mm and 4.0 mm Cannulated Screws

by David Seligson, M.D.

Professor Department of Orthopaedics  
University of Louisville- Louisville, Kentucky  
Chief of Fracture Service

## Contents

Design Features .....	3
Surgical Technique — Open .....	4
Surgical Technique — Percutaneous.....	6
Screw Removal .....	8
4.0 mm Cannulated Screw	
Design Features .....	9
Surgical Technique .....	10
Technique Options .....	12
Screw Removal .....	14
Catalog Information .....	15

Nota Bene: The technique description herein is made available to the healthcare professional to illustrate the author's suggested treatment for the uncomplicated procedure. In the final analysis, the preferred treatment is that which addresses the needs of the specific patient.

**The following statement is required by the U.S. FDA. WARNING:  
This device is not approved for screw attachment or fixation to the  
posterior elements (pedicles) of the cervical, thoracic, or lumbar spine.**



# Design Features- 6.5 mm Cannulated Screw

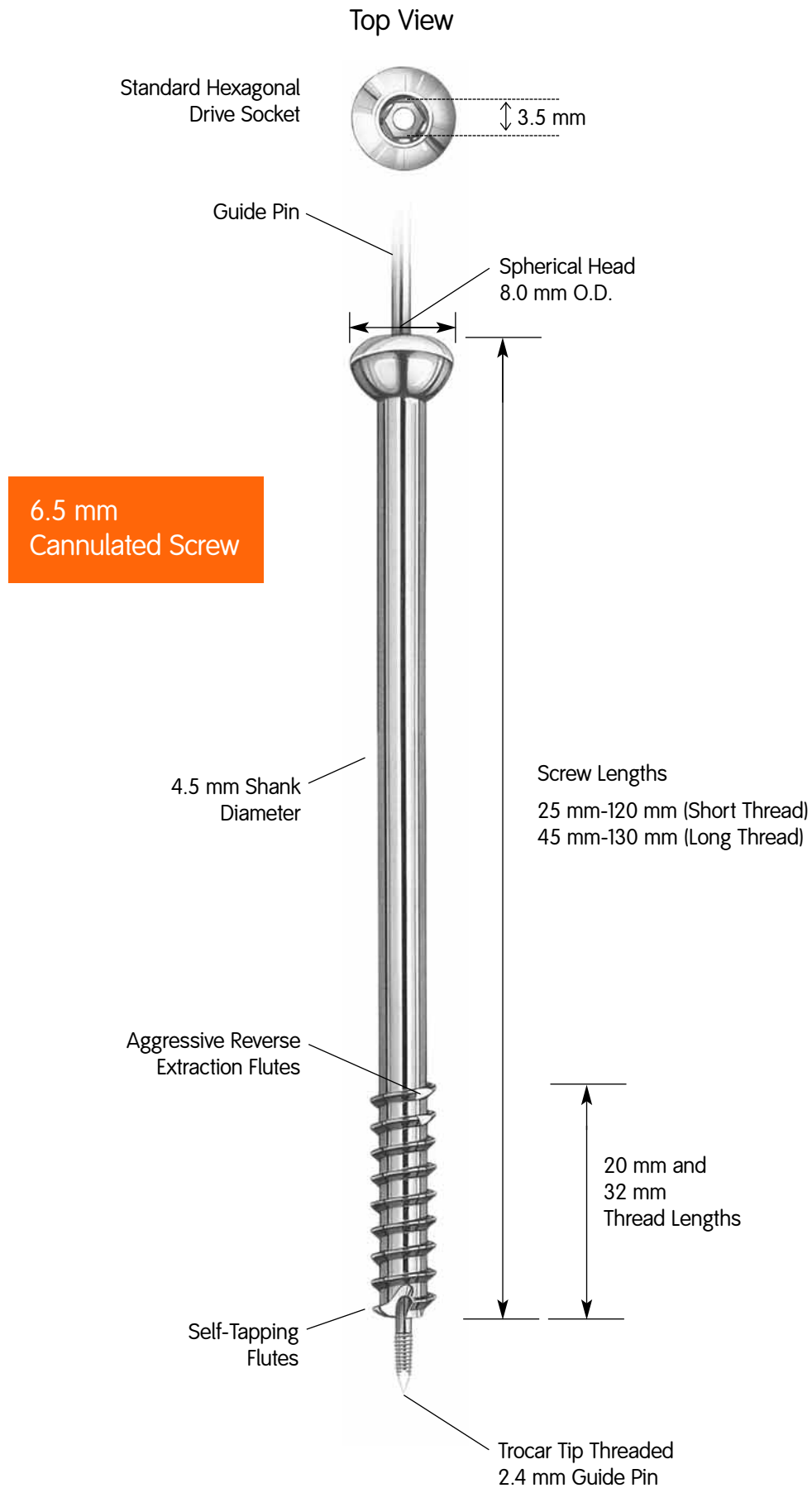

# 6.5 mm Open Surgical Technique

## 1. Insert Guide Pin

The 2.4 mm Guide Pin (41-0236) slips into the 6.5 mm Quick-Chuck Adapter (7111-0306)\* by pulling back the cap on the adapter. The guide pin is then inserted quickly and easily into bone. (Optional: the 4.7 mm Twist Drill (21-0446) is provided to notch the cortex before inserting the pin. This helps prevent the guide pin from deflecting off the bone.) When removing the instruments from the adapter, it may be necessary to first rotate the power source 90° counterclockwise.

\*The 6.5 mm Quick-Chuck Adapter is compatible with  
\*Amsco Hall, Jacobs, and Stryker power equipment.

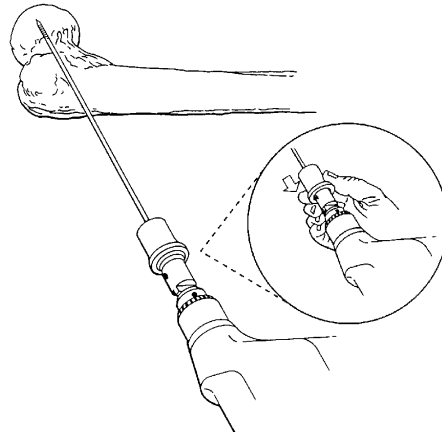

## 2. Insert Parallel Pins

Once the 6.5 mm Cannulated Screw Parallel Pin Guide (7111-0305) is placed over the initial guide pin, the pin block is stationary, and the instrument can be rotated for the placement of multiple parallel pins. The spacing of the pin holes in the instrument prevents the screw heads from overlapping in any configuration.

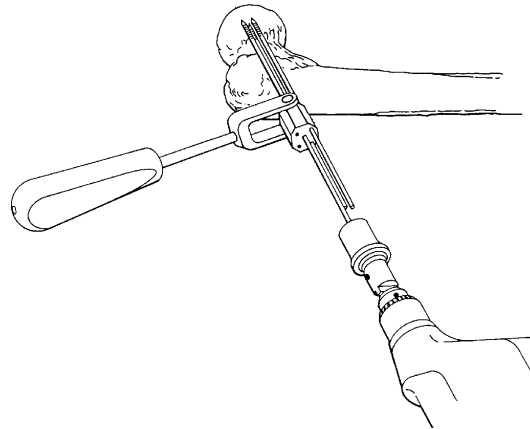

## 3. Measure

The 6.5 mm Cannulated Screw Direct Measuring Gauge (7111-0308) is placed over the guide pin and directly against bone for accurate measurement. Screw length measurement is read from the back of the guide pin.

**Note: The Direct Measuring Gauge is calibrated to display the actual length of guide pin within the bone. Overall screw lengths of the 6.5 mm Cannulated Screw are measured from the top of the head to the tip of the screw. Therefore, if the screw head is not countersunk, the tip of the screw is 5 mm short of the tip of the guide pin (head height = 5 mm).**

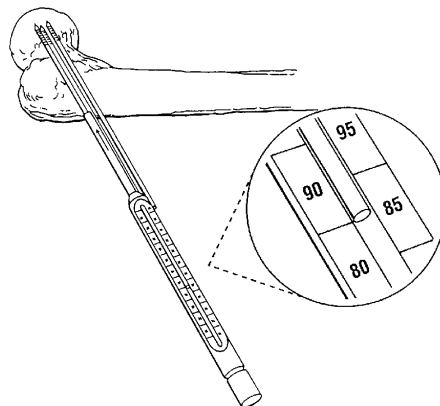

# 6.5 mm Open Surgical Technique

## 4. Ream

The 4.8 mm Cannulated Reamer (11-0069) slips easily into the Quick-Chuck Adapter and is used to ream the hole for the screw. In soft bone, reaming for the entire length of the screw is unnecessary. Reaming 5 mm short of the screw measurement prevents the reamer from engaging the threaded tip of the guide pin, avoiding inadvertent guide pin removal.

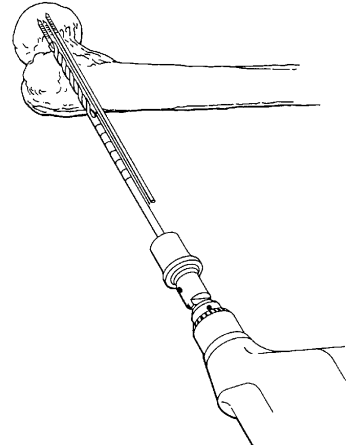

## 5. Tap

Use of the 6.5 mm Cannulated Screw Tap (11-0071) is optional, because the 6.5 mm Cannulated Screw is self-tapping. Tapping enables the screw to pass smoothly through the near cortex, so reduction can be maintained.

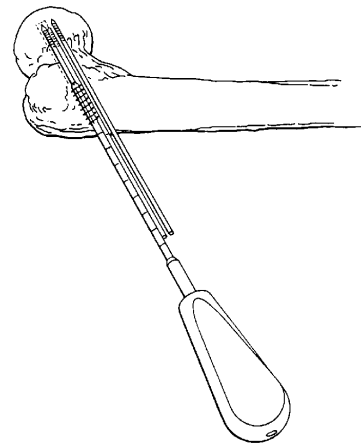

## 6. Insert Screw

The 6.5 mm Cannulated Screwdriver with Countersink (11-0120) has a built-in countersink to create a recess in the bone for low profile seating of the screw head. After countersinking, the appropriate length screw is loaded onto the screwdriver and inserted over the guide pin into the bone.

Repeat steps 3 through 6 for placement of multiple screws.

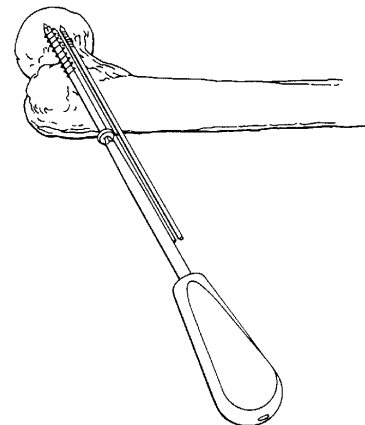

## Alternative Technique

The 6.5 mm Cannulated Screw can be inserted over the guide pin without predrilling or pretapping. In dense bone, however, predrilling and pretapping are recommended to facilitate screw insertion.

# 6.5 mm Percutaneous Surgical Technique

## 1. Insert Stacked Sleeves Through Soft Tissues

The percutaneous stacked sleeve assembly is inserted through the soft tissues and placed against the cortex. All of the surgical steps can be performed through the stacked sleeves, which include the outer 8.0 mm Drill Sleeve (7111-0300), 4.8 mm Black Drill Sleeve (7111-0301), 2.4 mm Red Drill Sleeve (7111-0302), and a 2.4 mm Trocar (7111-0303). Once the sleeve assembly is placed against the cortex, the 2.4 mm Trocar can be tapped with a mallet to dimple the bone.

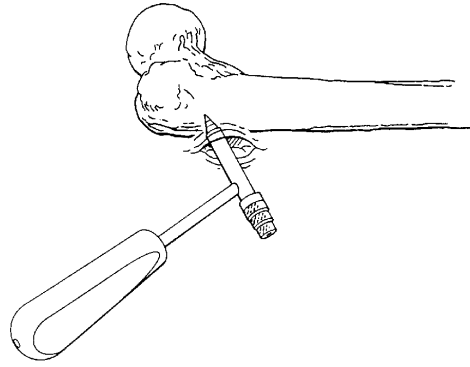

## 2. Insert Guide Pin

The 2.4 mm Trocar is removed. The 2.4 mm Guide Pin (41-0236) slips into the 6.5 mm Quick-Chuck Adapter (7111-0306)\* by pulling back the cap on the adapter. The guide pin is then inserted through the 2.4 mm Red Drill Sleeve and advanced into bone. When removing the instruments from the adapter, it may be necessary to first rotate the power source 90° counterclockwise.

\*The 6.5 mm Quick-Chuck Adapter is compatible with  
\*Amsco Hall, Jacobs, and Stryker power equipment.

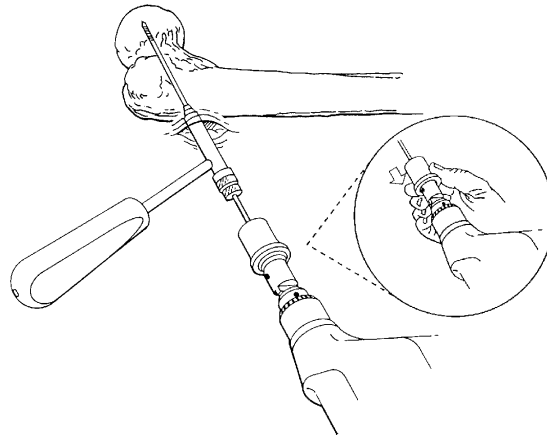

## 3. Measure

The 2.4 mm Red Drill Sleeve is removed. The Direct Measuring Gauge (7111-0308) is placed over the guide pin and inserted through the 4.8 mm Black Drill Sleeve. The gauge is positioned directly against bone for accurate measurement. Screw length measurement is read from the back of the guide pin.

Note: The Direct Measuring Gauge is calibrated to display the actual length of guide pin within the bone. Overall screw lengths of the 6.5 mm Cannulated Screw are measured from the top of the head to the tip of the screw. Therefore, if the screw head is not countersunk, the tip of the screw is 5 mm short of the tip of the guide pin (head height = 5 mm).

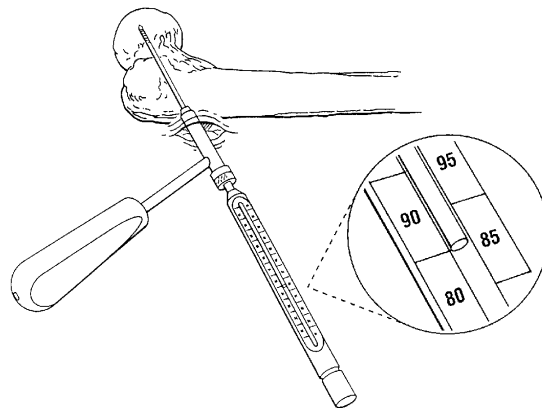

# 6.5 mm Percutaneous Surgical Technique

## 4. Ream

The 4.8 mm Cannulated Reamer (11-0069) slips easily into the Quick-Chuck Adapter. The reamer is used through the 4.8 mm Black Drill Sleeve to ream the hole for the screw. In soft bone, reaming for the entire length of the screw is unnecessary. Reaming 5 mm short of the screw measurement prevents the reamer from engaging the threaded tip of the guide pin, avoiding inadvertent guide pin removal.

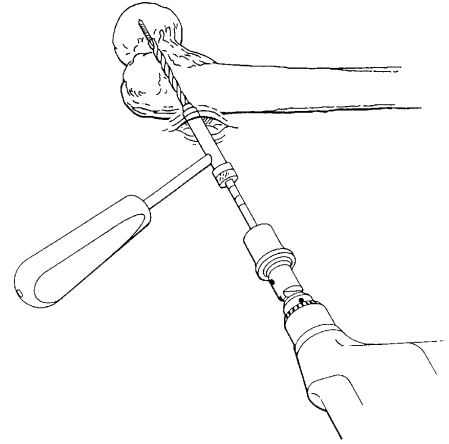

## 5. Tap

The 4.8 mm Black Drill Sleeve is removed. Use of the 6.5 mm Cannulated Screw Tap (11-0071) is optional, because the 6.5 mm Cannulated Screw is self-tapping. Tapping is performed through the outer 8.0 mm Drill Sleeve. Tapping enables the screw to pass smoothly through the near cortex, so reduction can be maintained.

Note: The calibrations on the Cannulated Reamer and Cannulated Screw Tap are not calibrated for the percutaneous stacked sleeves.

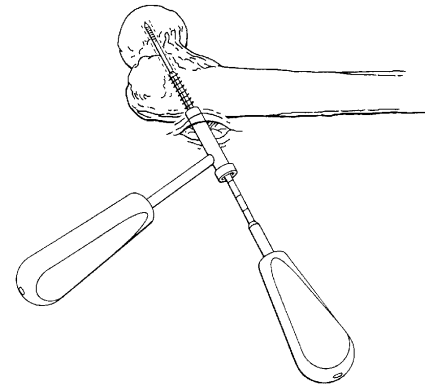

## 6. Insert Screw

Both countersinking and screw insertion are performed through the outer 8.0 mm Drill Sleeve. The 6.5 mm Cannulated Screwdriver with Countersink (11-0120) has a built-in countersink, used to create a recess in the bone for low profile seating of the screw head. After countersinking, the appropriate length screw is loaded onto the screwdriver and inserted over the guide pin into the bone.

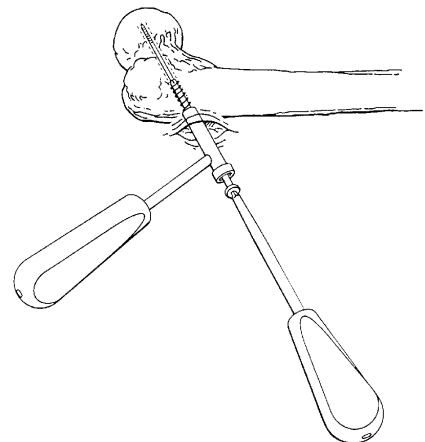

### Alternative Technique

The 6.5 mm Cannulated Screw can be inserted over the guide pin without predrilling or pretapping. In dense bone, however, predrilling and pretapping are recommended to facilitate screw insertion.

# 6.5 mm Open Surgical Technique

## Screw Extraction —

Screw extraction should be performed with the 3.5 mm Solid Hex Screwdriver (11-5035). The 6.5 mm Cannulated Screwdriver with Countersink (11-0120) should not be used for screw removal.

If complications arise during screw extraction, the screw can be removed with the 6.5 mm Cannulated Screw Extractor (7111-0307). The Extractor is tapped lightly into the cannulation of the screw with a mallet. The Extractor is then turned counterclockwise and bores into the inner wall of the screw to facilitate removal.

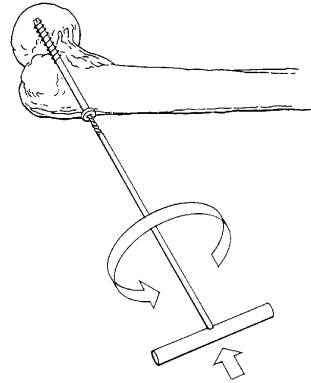

# Design Features- 4.0 mm Cannulated Screw

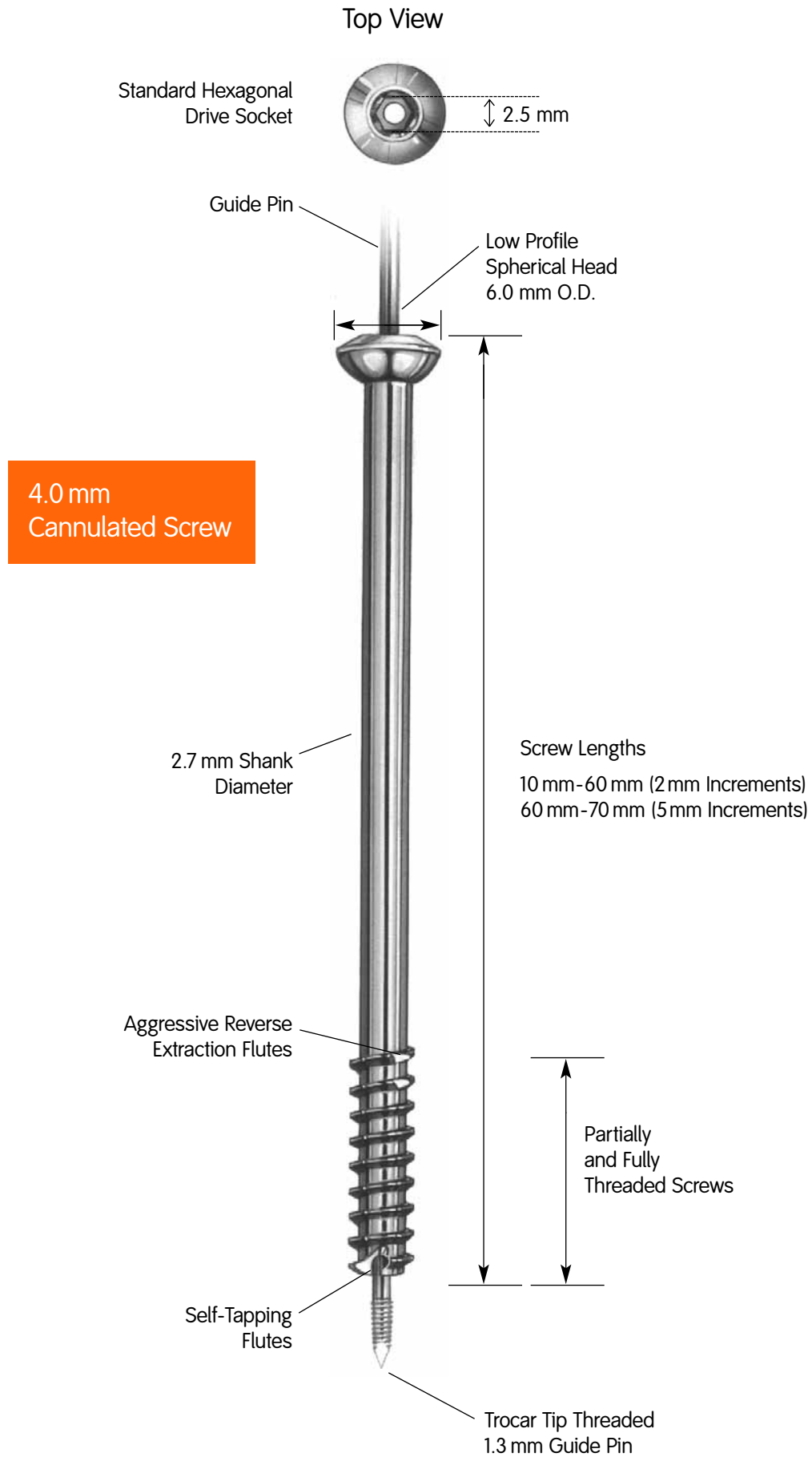

# 4.0 mm Surgical Technique

## 1. Insert Guide Pin

The 1.3 mm Drill Sleeve (11-7076) is inserted into the 4.0 mm Drill Sleeve (11-7077). This sleeve assembly is inserted through the soft tissues and placed against the near cortex. The 1.3 mm Guide Pin (12-8047 or 12-8039) slips into the 4.0 mm Quick-Chuck Adapter (7111-7082)\* by pulling back the cap on the adapter. The guide pin is inserted through the sleeves and advanced into bone. When removing the instruments from the adapter, it may be necessary to first rotate the power source 90° counterclockwise.

\*The 4.0 mm Quick-Chuck Adapter is compatible with  
\*Amsco Hall, Jacobs, and Stryker power equipment.

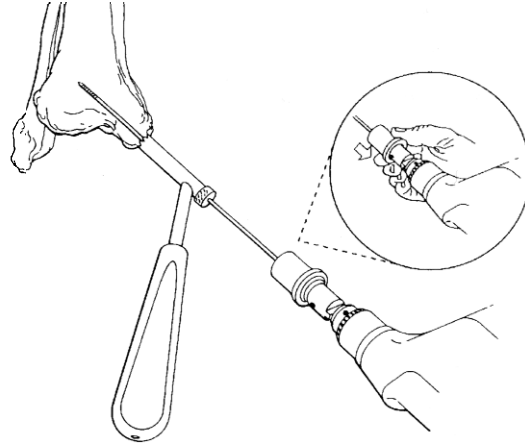

## 2. Measure

The 4.0 mm Cannulated Screw Sleeve Measuring Gauge (11-7072) is placed against the back of the 1.3 mm Drill Sleeve to determine the length of screw needed. Screw length measurement is read from the back of the guide pin.

Note: The 4.0 mm Cannulated Screw Sleeve Measuring Gauge is calibrated to display the actual length of guide pin within the bone. Overall screw lengths of the 4.0 mm Cannulated Screw are measured from the top of the head to the tip of the screw. Therefore, if the screw head is not countersunk, the tip of the screw is 3 mm short of the tip of the guide pin (head height = 3 mm).

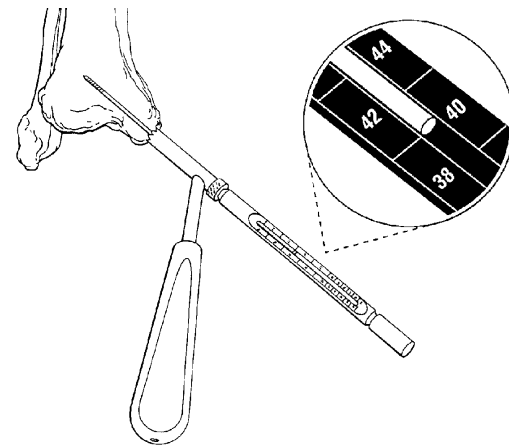

## 3. Ream Cortex

Remove the 1.3 mm Drill Sleeve from the 4.0 mm Drill Sleeve. The 4.0 mm Cannulated Cortex Reamer (11-7067) slips into the 4.0 mm Quick-Chuck Adapter and can be used through the 4.0 mm Drill Sleeve. Use of the cortex reamer is optional. The cortex reamer is 4 mm in diameter, and is used to ream the near cortex only. Its purpose is two-fold: to prolong the cutting life of the 2.7 mm Cannulated Screw Reamer, and to overdrill the near cortex and lag fragments with a fully threaded 4.0 mm Cannulated Screw.

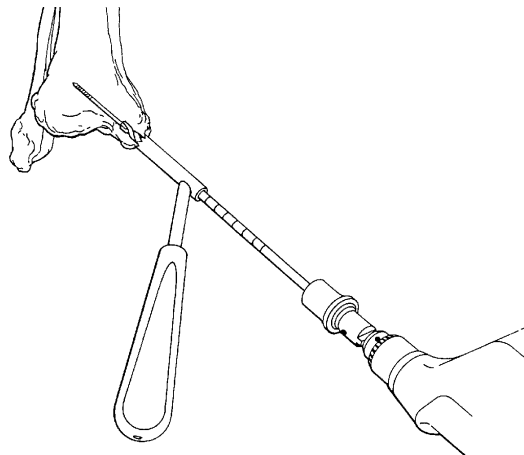

# 4.0 mm Surgical Technique

## 4. Ream

The 2.7 mm Cannulated Screw Reamer (11-7066) slips into the Quick-Chuck Adapter and is used through the 4.0 mm Drill Sleeve to ream the hole for the screw. In soft bone, reaming for the entire length of the screw is unnecessary. Reaming 5 mm short of the screw measurement prevents the reamer from engaging the threaded tip of the guide pin, avoiding inadvertent guide pin removal.

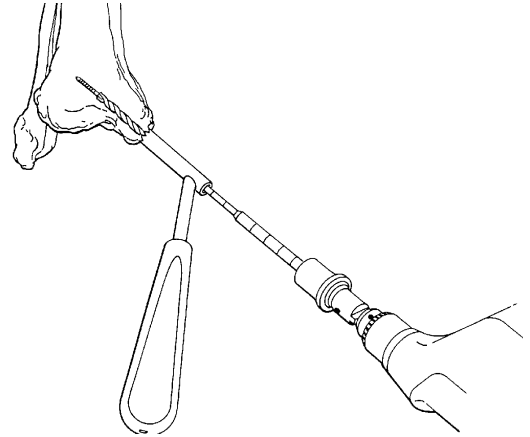

## 5. Tap

Use of the 4.0 mm Cannulated Screw Tap (11-7079) is optional, because the 4.0 mm Cannulated Screw is self-tapping. Tapping is performed through the 4.0 mm Drill Sleeve. Tapping enables the screw to pass smoothly through the near cortex, so reduction can be maintained.

Note: All of the calibrations on the instruments are read from the back of the 4.0 mm drill sleeve.

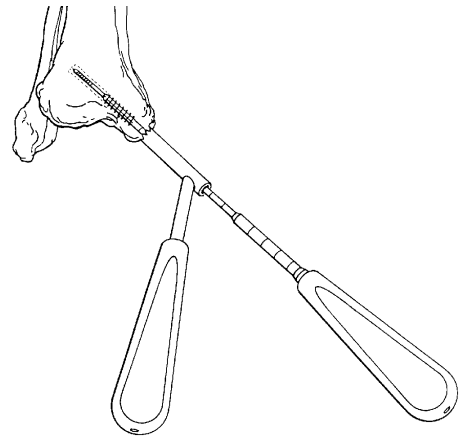

## 6. Insert Screw

Remove the 4.0 mm Drill Sleeve. The 4.0 mm Cannulated Screwdriver with Countersink (11-7070) has a built-in countersink, used to create a recess in the bone for low profile seating of the screw head. After countersinking, the appropriate length screw is loaded onto the screwdriver and inserted over the guide pin into the bone.

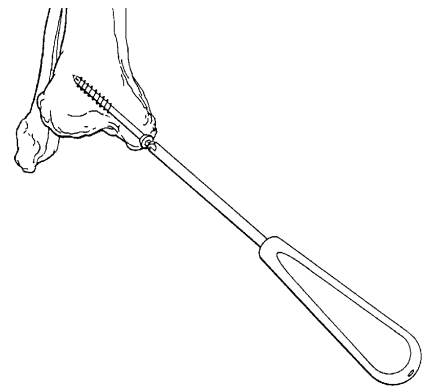

### Alternative Technique

The 4.0 mm Cannulated Screw can be inserted over the guide pin without predrilling or pretapping. In dense bone, however, predrilling and pretapping are recommended to facilitate screw insertion.

# 4.0 mm Technique Options

## 1. Power Insertion of Screws

The Self-Holding Screwdriver (7111-7081) slips easily into the Quick-Chuck Adapter and can be used for power insertion of 4.0 mm Cannulated Screws. The Cannulated Screwdriver should always be used for final, manual seating of the screw.

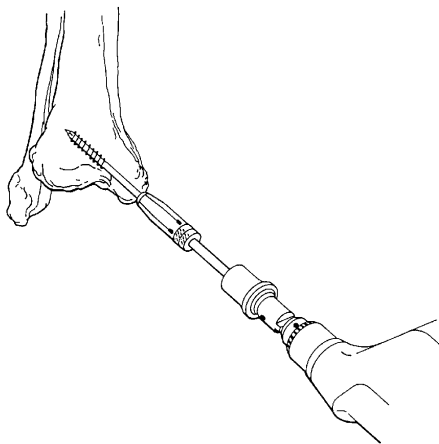

## 2. Direct Measure

The 4.0 mm Cannulated Screw Direct Measuring Gauge (7111-7083) can be placed over the guide pin and directly against bone to determine screw length. Screw length measurement is read from the back of the guide pin.

Note: The 4.0 mm Cannulated Screw Direct Measuring Gauge is calibrated to display the actual length of guide pin within the bone. Overall screw lengths of the 4.0 mm Cannulated Screw are measured from the top of the head to the tip of the screw. Therefore, if the screw head is not countersunk, the tip of the screw is 3 mm short of the tip of the guide pin (head height = 3 mm).

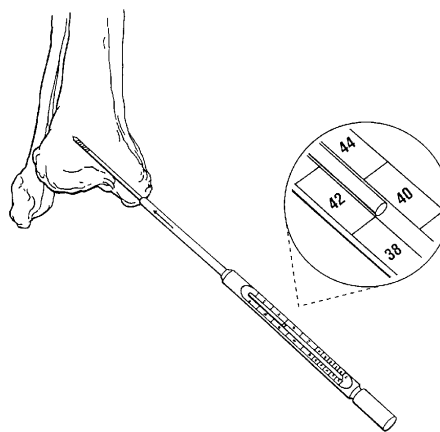

## 3A. Insert Parallel Pins

The 1.3 mm Parallel Pin Guide (7111-7080) can be used to place multiple parallel pins. The 1.3 mm Parallel Pin Guide slips onto the 4.0 mm Drill Sleeve and is tightened down with a twist knob. The pin guide can be rotated and placed in any plane — up, down, and around the drill sleeve. Within the pin guide, the sliding block can be set at fixed distances from 8 mm to 20 mm.

**Note: To ensure a smoother, more simplistic surgical procedure, the Parallel Pin Guide should be placed onto the 4.0 mm Drill Sleeve prior to inserting the initial guide pin.**

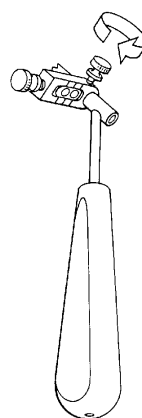

## 4.0 mm Technique Options

**3B.** The 1.3 mm Drill Sleeve is inserted into one of the holes in the 1.3 mm Parallel Pin Guide. A guide pin can be advanced through the drill sleeve into the bone.

Note: It is not necessary that the 1.3 mm Drill Sleeve snap into the hole in the 1.3 mm Parallel Pin Guide, but the drill sleeve must contact bone for accurate measurement.

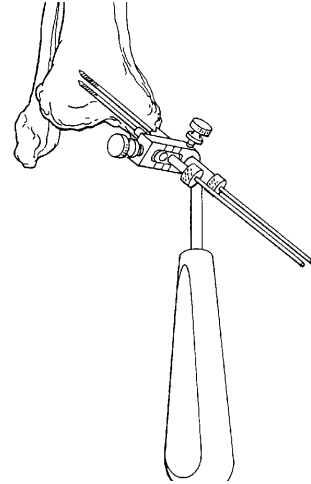

**3C.** The screw length can be determined with the 4.0 mm Cannulated Screw Sleeve Measuring Gauge. The gauge is placed directly against the back of the 1.3 mm Drill Sleeve to make the measurement. Screw length measurement is read from the back of the gauge pin.

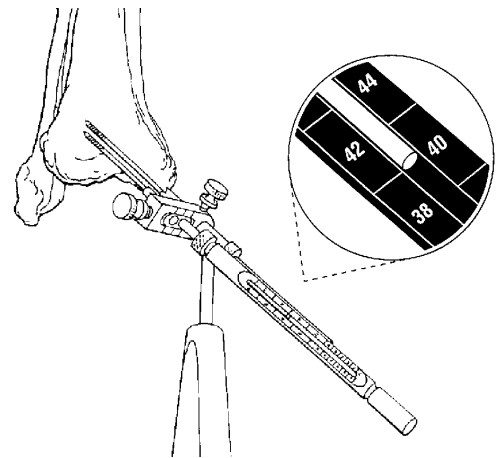

**3D.** After the initial screw has been inserted over the initial guide pin, the 4.0 mm Drill Sleeve can be placed over the 1.3 mm Parallel Pin Guide to protect the soft tissues while reaming and tapping for the parallel screw.

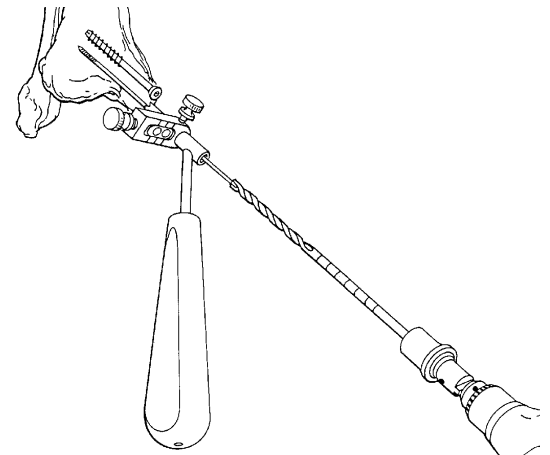

# 4.0 mm Screw Removal

## Screw Extraction

Screw extraction is performed with the 4.0 mm Cannulated Screwdriver with Countersink. The screwdriver has a 2.5 mm hexagonal tip. If complications arise during screw extraction, the screw can be removed with the 4.0 mm Cannulated Screw Extractor (7111-7084). The Extractor is tapped lightly into the cannulation of the screw with a mallet. The Extractor is then turned counterclockwise and bores into the inner wall of the screw to facilitate removal.

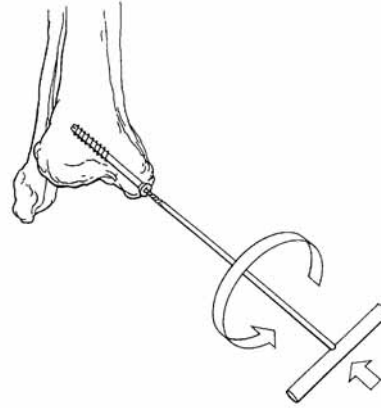

# 6.5 mm Implants Catalog Information

## 6.5 mm Cannulated Screws

Titanium (Nonsterile Package)  
20 mm Thread Length

Cat. No.	Screw Length
71161040	40 mm
71161045	45 mm
71161050	50 mm
71161055	55 mm
71161060	60 mm
71161065	65 mm
71161070	70 mm
71161075	75 mm
71161080	80 mm
71161085	85 mm
71161090	90 mm
71161095	95 mm
71161100	100 mm
71161105	105 mm
71161110	110 mm



20 mm Thread Length

## 6.5 mm Cannulated Screws

Stainless Steel (Sterile Package)

Cat. No.	Screw Length	Thread Length
121625	25 mm	16 mm
121626	30 mm	16 mm
121627	35 mm	20 mm
121628	40 mm	20 mm
121629	45 mm	20 mm
121630	50 mm	20 mm
121631	55 mm	20 mm
121632	60 mm	20 mm
121633	65 mm	20 mm
121634	70 mm	20 mm
121635	75 mm	20 mm
121636	80 mm	20 mm
121637	85 mm	20 mm
121638	90 mm	20 mm
121639	95 mm	20 mm
121640	100 mm	20 mm
121641	105 mm	20 mm
121642	110 mm	20 mm
121643	115 mm	20 mm
121644	120 mm	20 mm



20 mm Thread Length

## 6.5 mm Titanium Washer

(Sterile Packaged) 6 per box  
Cat. No. 7110-2000

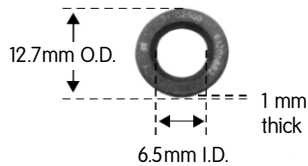

## 6.5 mm Stainless Steel Washer

(Sterile Packaged) 6 per box  
Cat. No. 12-1680

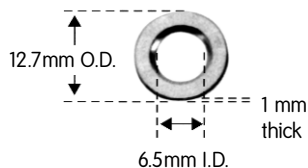

71100045	45 mm	32 mm
71100050	50 mm	32 mm
71100055	55 mm	32 mm
71100060	60 mm	32 mm
71100065	65 mm	32 mm
71100070	70 mm	32 mm
71100075	75 mm	32 mm
71100080	80 mm	32 mm
71100085	85 mm	32 mm
71100090	90 mm	32 mm
71100095	95 mm	32 mm
71100100	100 mm	32 mm
71100105	105 mm	32 mm
71100110	110 mm	32 mm
71100115	115 mm	32 mm
71100120	120 mm	32 mm
71100125	125 mm	32 mm
71100130	130 mm	32 mm



32 mm Thread Length

# 6.5 mm Instruments

6.5 mm Quick Chuck Adapter  
(mates with Amsco Hall, Stryker,  
and Jacobs power equipment)  
Cat. No. 71110306



4.7 mm Twist Drill  
Cat. No. 210446



8.0 mm Drill Sleeve  
Cat. No. 71110300



4.8 mm Drill Sleeve (Black)  
Cat. No. 71110301



2.4 mm Drill Sleeve (Red)  
Cat. No. 71110302



2.4 mm Trocar  
Cat. No. 71110303



Guide Pin 2.4 mm x 230 mm  
(Nonsterile Packaged) 6 per box  
Cat. No. 410236



6.5 mm Cannulated Screw  
Direct Measuring Gauge  
Cat. No. 71110308



6.5 mm Cannulated Screw  
Parallel Pin Guide  
Cat. No. 71110305



4.8 mm Cannulated Reamer  
Cat. No. 110069



# 6.5 mm Instruments

6.5 mm Cannulated Screw Tap  
Cat. No. 110071



Cannulated Screwdriver with Countersink  
(for insertion only)  
Cat. No. 110120



3.5 mm Solid Hex Screwdriver  
(for extraction only)  
Cat. No. 115035



6.5 mm Cannulated Screw Extractor  
Cat. No. 71110307  
Obturator  
Cat. No. 116500



6.5 mm Cannulated Screw Instrument Tray  
Cat. No. 7111-0309

6.5 mm Cannulated Stainless Steel  
Screw Implant Tray  
Cat. No. 71110310



6.5 mm Cannulated Tray  
Label Conversion Kit from SST to TI  
Cat. No. 71180759

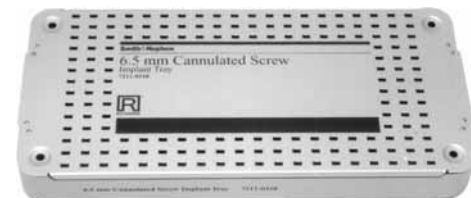

# 6.5 mm Cannulated Screw Sets

## 6.5mm Cannulated Screw Instrument Set

Cat. No. 71110312

Cat. No.	Description	Qty.
110069	Cannulated Reamer 4.8 mm	1
110071	Universal Cannulated Screw Tap 6.5m	1
110120	6.5 mm Cann Scdr W/ Countersink	1
115035	Hex Scdr For 4.5 mm And 6.5 mm Bn Scr	1
116500	Obturator (For 6.5 mm Cannulated Scr	1
210446	Twist Drill 4.7 mm Dia 127.0 mm Long	1
410236	Guide Pin 230 mm X 2.4 mm	6
71110300	8.0 mm Drill Sleeve With Handle	1
71110301	4.8 mm Drill Sleeve W/o Handle	1
71110302	2.4 mm Drill Sleeve Without Handle	1
71110303	2.4 mm Trocar	1
71110305	6.5 mm Cann Scr Parallel Pin Gde	1
71110306	6.5 mm Quick-chuck Adapter	1
71110307	6.5 mm Cannulated Screw Extractor	1
71110308	6.5 mm Cann Scr Direct Measuring Gauge	1
71110309	6.5 mm Cannulated Screw Instrument Tray	1

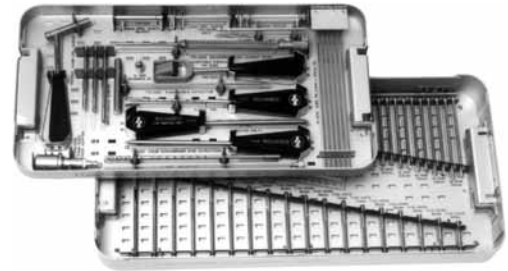

## 6.5 mm Universal Cannulated Screw Set

Cat. No. 71100202

Cat. No.	Description	Qty.
121625	25 mm	2
121626	30 mm	2
121627	35 mm	2
121628	40 mm	2
121629	45 mm	2
121630	50 mm	2
121631	55 mm	2
121632	60 mm	2
121633	65 mm	2
121634	70 mm	2
121635	75 mm	2
121636	80 mm	2
121637	85 mm	2
121638	90 mm	2
121639	95 mm	2
121640	100 mm	2
121641	105 mm	2
121642	110 mm	2
121643	115 mm	2
121644	120 mm	2
121680	Washer 12.7 mm OD X 6.5 mm Id	6

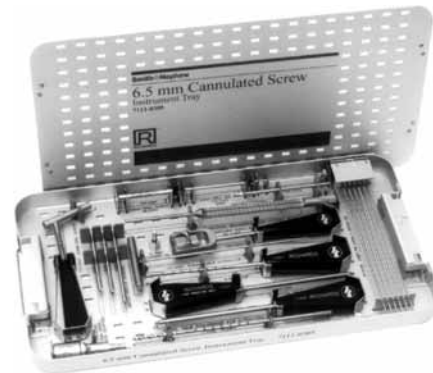

# 4.0 mm Implants

## 4.0 mm Cannulated Screws

Titanium Partially Threaded  
(Sterile Package)

Cat. No.	Screw Length	Thread Length
71101020	20 mm	8 mm
71101022	22 mm	9 mm
71101024	24 mm	10 mm
71101026	26 mm	12 mm
71101028	28 mm	14 mm
71101030	30 mm	14 mm
71101032	32 mm	14 mm
71101034	34 mm	14 mm
71101036	36 mm	14 mm
71101038	38 mm	14 mm
71101040	40 mm	14 mm
71101042	42 mm	14 mm
71101044	44 mm	15 mm
71101046	46 mm	15 mm
71101048	48 mm	15 mm
71101050	50 mm	15 mm
71101052	52 mm	15 mm
71101054	54 mm	15 mm
71101056	56 mm	15 mm
71101058	58 mm	15 mm
71101060	60 mm	15 mm
71101065	65 mm	15 mm
71101070	70 mm	15 mm



## 4.0 mm Cannulated Screws

Stainless Steel Partially Threaded  
(Sterile Package)

Cat. No.	Screw Length	Thread Length
121810	10 mm	5 mm
121812	12 mm	5 mm
121814	14 mm	5 mm
121816	16 mm	6 mm
121818	18 mm	7 mm
121820	20 mm	8 mm
121822	22 mm	9 mm
121824	24 mm	10 mm
121826	26 mm	12 mm
121828	28 mm	14 mm
121830	30 mm	14 mm
121832	32 mm	14 mm
121834	34 mm	14 mm
121836	36 mm	14 mm
121838	38 mm	14 mm
121840	40 mm	14 mm
121842	42 mm	14 mm
121844	44 mm	15 mm
121846	46 mm	15 mm
121848	48 mm	15 mm
121850	50 mm	15 mm
121852	52 mm	15 mm
121854	54 mm	15 mm
121856	56 mm	15 mm
121858	58 mm	15 mm
121860	60 mm	15 mm
121865	65 mm	15 mm
121870	70 mm	15 mm



## Stainless Steel Fully Threaded

(Sterile Package)

Cat. No.	Screw Length
222820	20 mm
222822	22 mm
222824	24 mm
222826	26 mm
222828	28 mm
222830	30 mm
222835	35 mm
222840	40 mm
222845	45 mm
222850	50 mm
222855	55 mm
222860	60 mm
222865	65 mm
222870	70 mm



## 4.0 mm Titanium Washer

(Sterile Packaged) 6 per box

Cat. No. 71101000

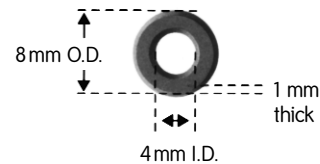

## 4.0 mm Stainless Steel Washer

(Sterile Packaged) 6 per box

Cat. No. 71120006

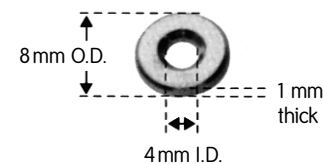

# 4.0 mm Instruments

## 4.0 mm Quick Chuck Adapter

(mates with Amsco Hall, Stryker,  
and Jacobs power equipment)

Cat. No. 71117082



## 4.0 mm Drill Sleeve

Cat. No. 117077



## 1.3 mm Drill Sleeve

Cat. No. 117076



## 1.3 mm Parallel Pin Guide

Cat. No. 71117080



## 1.3 mm Guide Pin

(Sterile Packaged) 6 per box

Cat. No. Description

128039 Bayonet Point

128047 Tip Threaded



## 4.0 mm Cannulated Screw Sleeve

Measuring Gauge

Cat. No. 117072



## 4.0 mm Cannulated Screw Direct

Measuring Gauge

Cat. No. 71117083



## 4.0 mm Cannulated Cortex Reamer

Cat. No. 117067



# 4.0 mm Instruments

2.7 mm Cannulated Screw Reamer  
Cat. No. 117066



4.0 mm Cannulated Screw Tap  
Cat. No. 117079



Self-Holding Screwdriver  
Cat. No. 71117081



4.0 mm Cannulated Screwdriver with Countersink  
Cat. No. 117070



4.0 mm Cannulated Screw Extractor  
Cat. No. 71117084



Obturator  
Cat. No. 116501



4.0 mm Cannulated Screw Instrument Tray  
Cat. No. 71117085



4.0 mm Cannulated Stainless Steel Screw Implant Tray  
Cat. No. 71117086

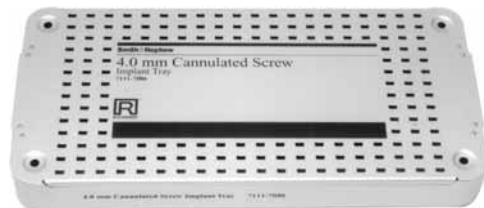

4.0 mm Cannulated TI Label  
Conversion Kit for SST to TI  
Cat. No. 71180760



# 4.0 mm Cannulated Screw Sets

## 4.0 mm Cannulated Screw System Set

Stainless Steel

Cat. No. 71117089

Cat. No.	Description	Qty.
116501	Obturator for 4.0 mm Cannulated Screw	1
117066	2.7 mm Cannulated Reamer for 4.0 mm Cannulated Screw	1
117067	4.0 mm Cannulated Cortex Reamer	1
117070	4.0 mm Cannulated Screwdrivers	1
117072	4.0 mm Sleeve Measurement Gauge	1
117076	4.0 mm Cannulated Scr Drv Sleeve 1.3 mm ID	2
117077	4.0 mm Cannulated Scr Drv Sleeve 4.0 mm ID	1
117079	4.0 mm Cannulated Screw Tap - Lonnger	1
121810	10 mm	3
121812	12 mm	3
121814	14 mm	3
121816	16 mm	3
121818	18 mm	3
121820	20 mm	3
121822	22 mm	3
121824	24 mm	3
121826	26 mm	3
121828	28 mm	3
121830	30 mm	3
121832	32 mm	3
121834	34 mm	3
121836	36 mm	3
121838	38 mm	3
121840	40 mm	3
121842	42 mm	3
121844	44 mm	3
121846	46 mm	3
121848	48 mm	3
121850	50 mm	3
121852	52 mm	3
121854	54 mm	3
121856	56 mm	3
121858	58 mm	3
121860	60 mm	3
121865	65 mm	3
121870	70 mm	3
128039	Guide Pin Bayonet 1.3 mm x 140 mm	6
128047	Guide Pin Trocar 1.3 mm x 140 mm	6

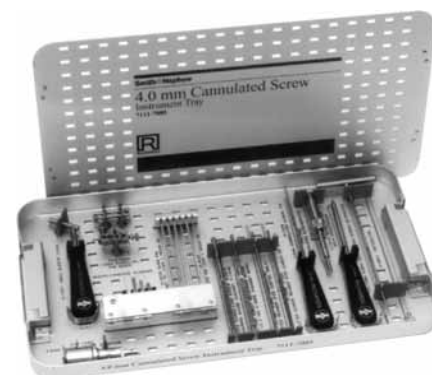
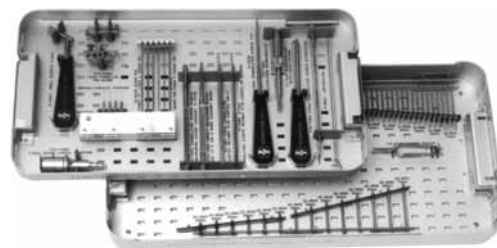

# 4.0 mm Cannulated Screw Sets

## 4.0 mm Cannulated Screw System Set (Continued)

Cat. No. 71117089

Fully Threaded

<b>Cat. No.</b>	<b>Description</b>	<b>Qty.</b>
222820	20 mm	1
222822	22 mm	1
222824	24 mm	1
222826	26 mm	1
222828	28 mm	1
222830	30 mm	1
222835	35 mm	1
222840	40 mm	1
222845	45 mm	1
222850	50 mm	1
222855	55 mm	1
222860	60 mm	1
222865	65 mm	1
222870	70 mm	1
71117080	1.3 mm Parallel Oin Guide	1
71117081	Self-Holding Screwdriver (2.5 mm Hex)	1
71117082	4.0 mm Quick Chuck Adapter	1
71117083	4.0 mm Direct Measure	1
71117084	4.0 mm Cannulated Scr Extractor	1
71117085	4.0 mm Cannulated Scr Instrument Tray	1
71117086	4.0 mm Cannulated Screw Implant Tray	1

## 4.0 mm Cannulated Screw Instrument Set

Cat. No. 71117090

<b>Cat. No.</b>	<b>Description</b>	<b>Qty.</b>
71117086	4.0 mm Cannulated Screw Implant Tray	1
116501	Obturator for 4.0 mm Cannulated Screw	1
117066	2.7 mm Cannulated Reamer for 4.0 mm Screw	1
117067	4.0 mm Cannulated Cortex Reamer	1
117070	4.0 mm Cannulated Screwdriver	1
117072	4.0 mm Sleeve Measuring Gauge	1
117076	4.0 mm Cannulated Scr Drill Sleeve 1.3 mm ID	2
117077	4.0 mm Cannulated Screw Drill Sleeve 4.0 mm ID	1
117079	4.0 mm Cannulated Screw Tap - Longer	1
128039	Guide Pin Bayonet Point 1.3 mm x 140 mm	6
128047	Guide Pin Trocar Point 1.3 mm x 140 mm	6
71117080	1.3 mm Parallel Guide Pin	1
71117081	Self Holding Screwdriver (2.5 mm Hex)	1
71117082	4.0 mm Quick Chuck Adapter	1
71117083	4.0 mm Direct Measure	1
71117084	4.0 mm Cannulated Scr Extractor	1
71117085	4.0 mm Cannulated Screw Instrument Tray	1

# 4.0 mm Cannulated Screw Sets

## 4.0 mm Cannulated Screw Implant Set

Stainless Steel Partially Threaded

Cat. No. 71100203

<b>Cat. No.</b>	<b>Description</b>	<b>Qty.</b>
121810	10 mm	3
121812	12 mm	3
121814	14 mm	3
121816	16 mm	3
121818	18 mm	3
121820	20 mm	3
121822	22 mm	3
121824	24 mm	3
121826	26 mm	3
121828	28 mm	3
121830	30 mm	3
121832	32 mm	3
121834	34 mm	3
121836	36 mm	3
121838	38 mm	3
121840	40 mm	3
121842	42 mm	3
121844	44 mm	3
121846	46 mm	3
121848	48 mm	3
121850	50 mm	3
121852	52 mm	3
121854	54 mm	3
121856	56 mm	3
121858	58 mm	3
121860	60 mm	3
121865	65 mm	3
121870	70 mm	3

## 4.0 mm Cannulated Screw Implant Set

Fully Threaded

Cat. No. 71100203

<b>Cat. No.</b>	<b>Description</b>	<b>Qty.</b>
222820	20 mm	1
222822	22 mm	1
222824	24 mm	1
222826	26 mm	1
222828	28 mm	1
222830	30 mm	1
222835	35 mm	1
222840	40 mm	1
222845	45 mm	1
222850	50 mm	1
222855	55 mm	1
222860	60 mm	1
222865	65 mm	1
222870	70 mm	1
71117086	4.0 mm Cannulated Screw Implant Tray	1

**Orthopaedics**

Smith & Nephew, Inc.  
1450 Brooks Road  
Memphis, TN 38116  
USA

[www.smith-nephew.com](http://www.smith-nephew.com)

Telephone: 901-396-2121  
Information: 1-800-821-5700  
Orders/Inquiries: 1-800-238-7538